

PLANTA

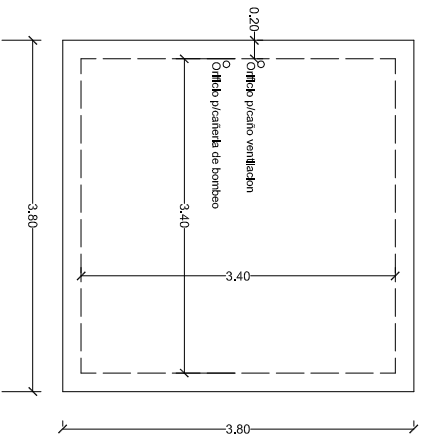

Losas de fondo

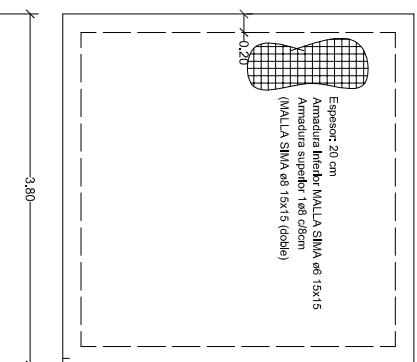

Losas superior (tapa)

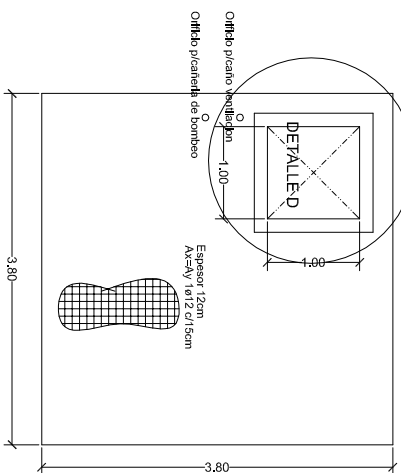

DETALLE A (losa)

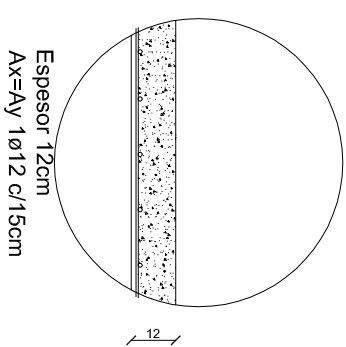

CORTE

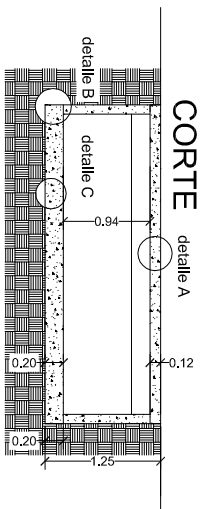

Tabique (vista)

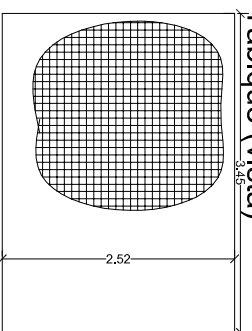

DETALLE B (tabique/platea)

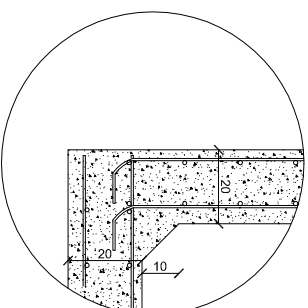

DETALLE C (platea)

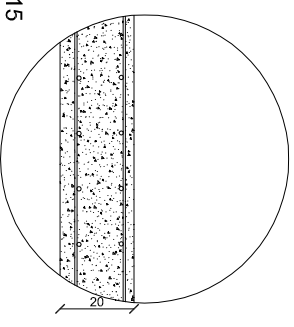

TABIQUE:
 Espesor 20cm
 Arm. interior MALLA SIMA ø8 15x15
 Arm. exterior MALLA SIMA ø6 15x15

PLATEA
 Espesor: 20 cm
 Armadura inferior MALLA SIMA ø6 15x15
 Armadura superior 1ø8 c/15cm en ambas direcciones

DETALLE D (acceso)

Planta

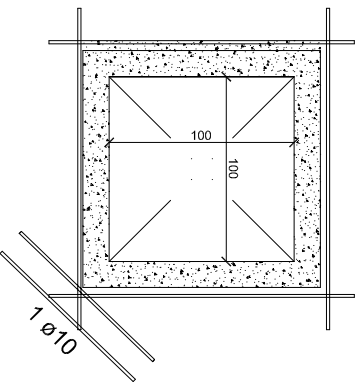

Corte

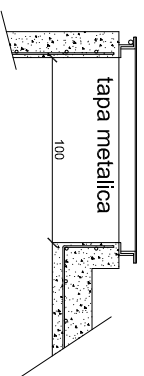

MUNICIPALIDAD DE VIEDMA

Obra: CISTERNA (ESTRUCTURA)

Ubicación: Plaza ALSINA -VIEDMA -RIO NEGRO